



INSTRUCTIONS D'ASSEMBLAGE
ASSEMBLY INSTRUCTIONS

MONARCH
SPECIALTIES INC.

I 7236

ETAGERE -
60" H / NOIR / METAL NOIR

BOOKCASE -
60" H / BLACK / BLACK METAL







**POUR DE L'ASSISTANCE OU POUR COMMANDER
DES PIÈCES CONTACTEZ NOTRE DÉPARTEMENT
DE SERVICE À LA CLIENTÈLE.**

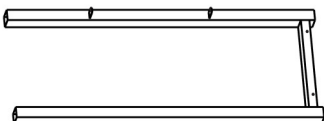

**FOR ASSISTANCE OR TO ORDER PARTS
CONTACT OUR CUSTOMER SERVICE DEPARTMENT**

WWW.MONARCHSERVICE.COM

LISTE DES PIÈCES
PARTS LIST

PIÈCE / PART #	IMAGE	DESCRIPTION	QTY / QTÉ
1		<p>BOTTOM FRAME CADRE DU BAS</p>	1
2		<p>TOP FRAME CADRE DE SURFACE</p>	1
3		<p>BOTTOM FRAME CADRE DU BAS</p>	1
4		<p>TOP FRAME CADRE DE SURFACE</p>	1
5		<p>SUPPORT LEG PATTE DE SOUTIEN</p>	2

LISTE DES PIÈCES
PARTS LIST

PIÈCE / PART #	IMAGE	DESCRIPTION	QTY / QTÉ
6	 A technical drawing of a support leg, which is a long, thin rectangular piece with a small notch at one end and a perpendicular flange at the other.	SUPPORT LEG PATTE DE SOUTIEN	2
7	 A technical drawing of a shelf panel, which is a thin, rectangular flat piece.	SHELF PANEL PANNEAU DE TABLETTE	4

LISTE DES PIÈCES DE MONTAGE
HARDWARE LIST

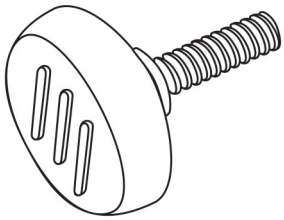
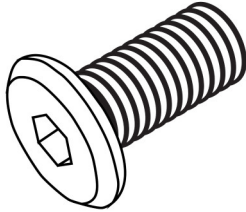
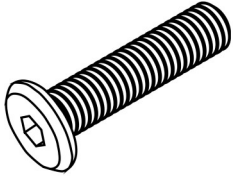
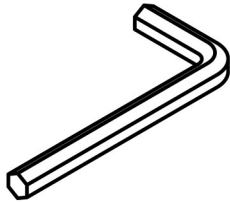
PIÈCE / PART #	IMAGE	DESCRIPTION	QTY / QTÉ
A		ADJUSTABLE LEG - Ø 1/4" X 3/4" PATTE AJUSTABLE - Ø 1/4" X 3/4"	6
B		ASSEMBLING BOLT - Ø 1/4" X 1/2" BOULON D'ASSEMBLAGE - Ø 1/4" X 1/2"	24
C		ASSEMBLING BOLT - Ø 1/4" X 1 1/2" BOULON D'ASSEMBLAGE - Ø 1/4" X 1 1/2"	8
D		HEX KEY CLÉ HEXAGONALE	1

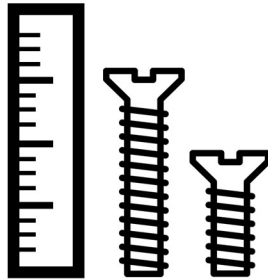

OUTIL DE VÉRIFICATION DE DIMENSIONS DES PIÈCES
HARDWARE DIMENSIONS VERIFICATION TOOL

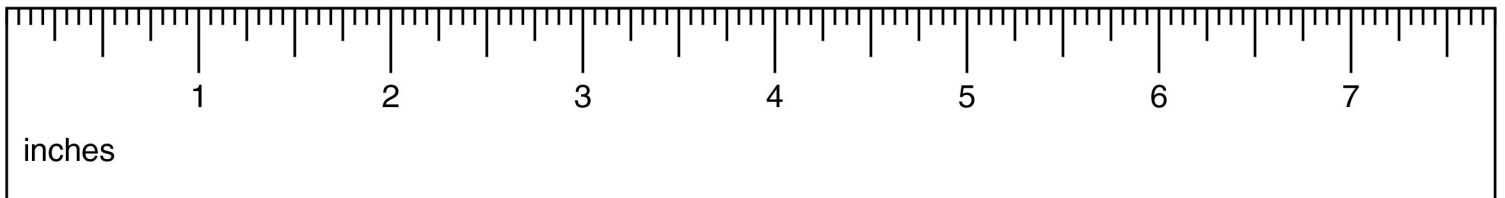

ÉTAPE / STEP 1

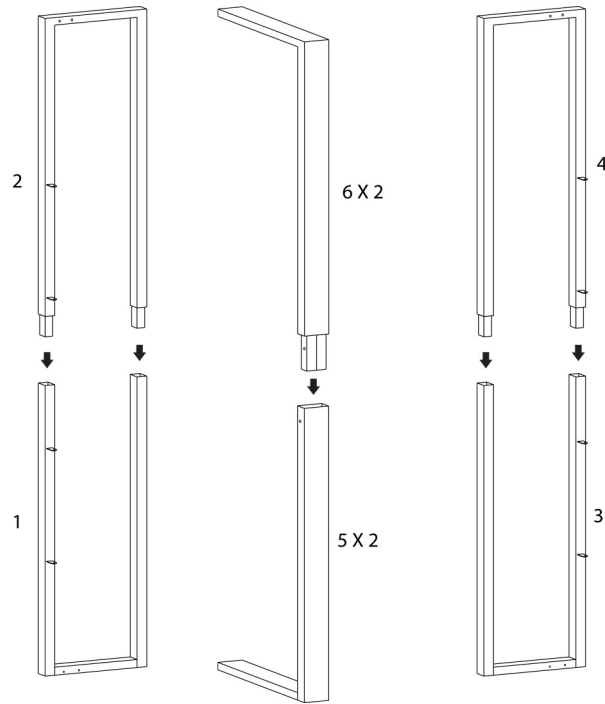

ÉTAPE / STEP 2

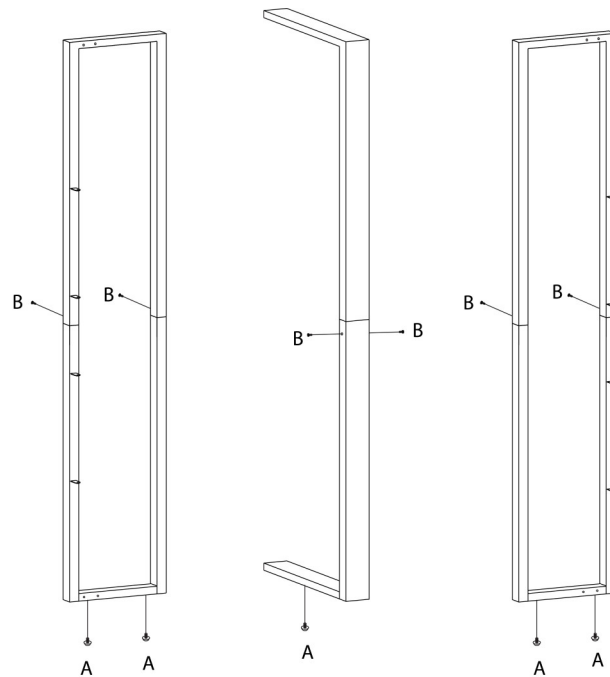

ÉTAPE / STEP 3

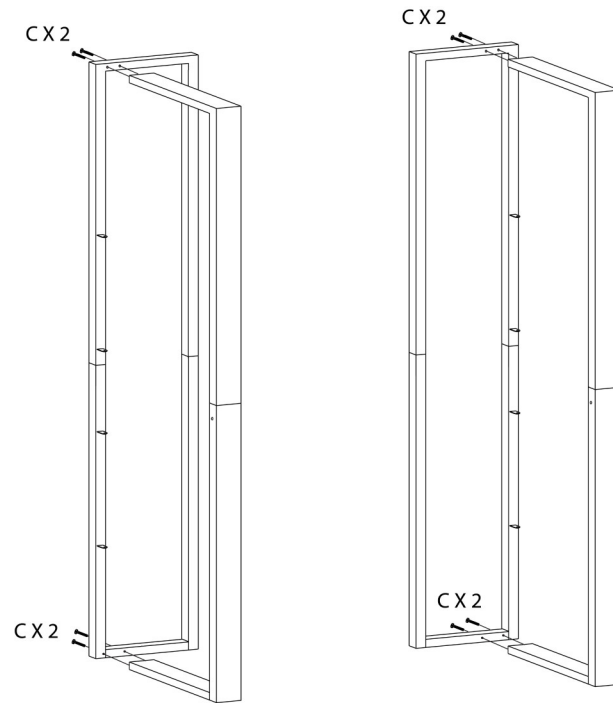

ÉTAPE / STEP 4

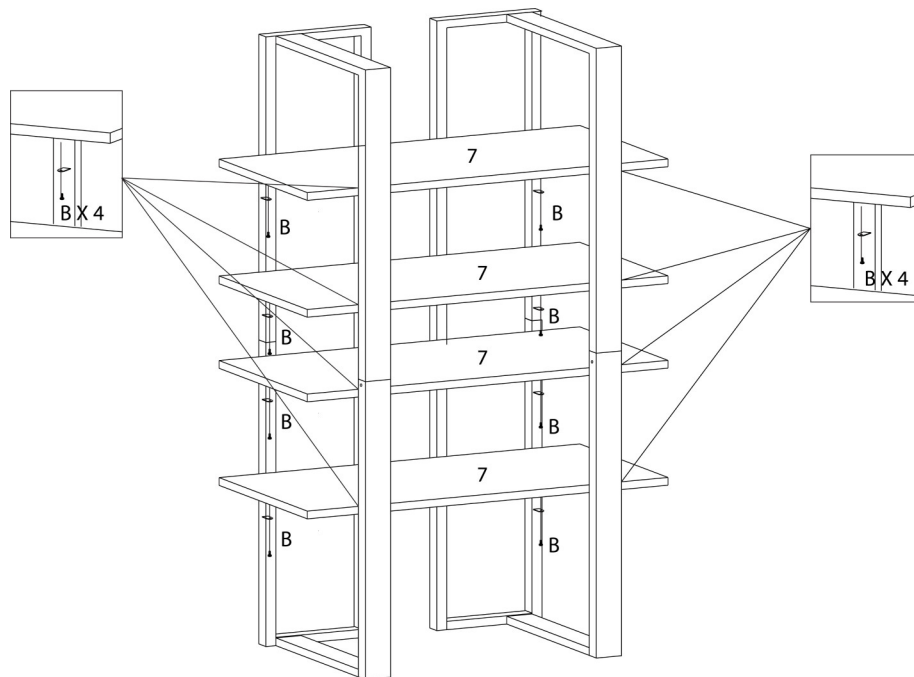

ÉTAPE / STEP 5

