



INSTRUCTIONS D'ASSEMBLAGE
ASSEMBLY INSTRUCTIONS

MONARCH
SPECIALTIES INC.

I 3171

TABLE D'APPOINT -
METAL CHROME / GRIS LUSTRE ET TIROIR

ACCENT TABLE -
CHROME METAL / GLOSSY GREY WITH A DRAWER





**POUR DE L'ASSISTANCE OU POUR COMMANDER
DES PIÈCES CONTACTEZ NOTRE DÉPARTEMENT
DE SERVICE À LA CLIENTÈLE.**

**FOR ASSISTANCE OR TO ORDER PARTS
CONTACT OUR CUSTOMER SERVICE DEPARTMENT**

WWW.MONARCHSERVICE.COM

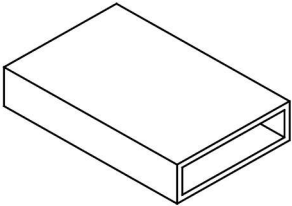
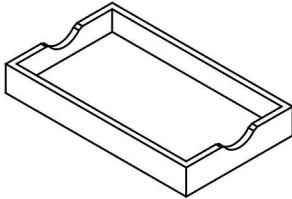
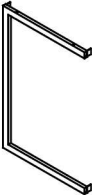
LISTE DES PIÈCES
PARTS LIST

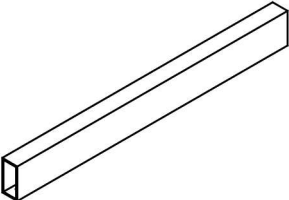
| PIÈCE / PART # | IMAGE | DESCRIPTION | QTY / QTÉ |
|----------------|---|--|-----------|
| 1 |  | TABLE TOP SURFACE DE TABLE | 1 |
| 2 |  | DRAWER TIROIR | 1 |
| 3 |  | FRONT FACING LEFT LEG PATTE AVANT GAUCHE | 1 |
| 4 |  | FRONT FACING RIGHT LEG PATTE AVANT DROITE | 1 |
| 5 |  | STRETCHER CHÂSSIS | 4 |

LISTE DES PIÈCES
PARTS LIST

| PIÈCE / PART # | IMAGE | DESCRIPTION | QTY / QTÉ |
|----------------|---|--------------------------------|-----------|
| 6 |  | BACK FRAME CADRE DU DOSSIER | 1 |

LISTE DES PIÈCES DE MONTAGE
HARDWARE LIST

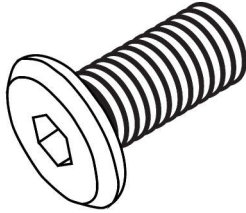
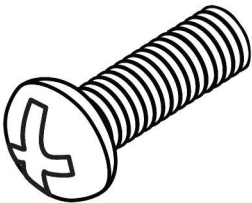
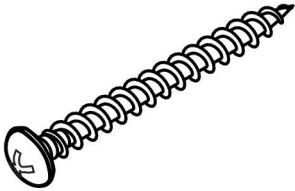
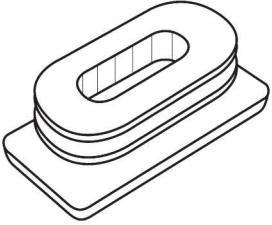
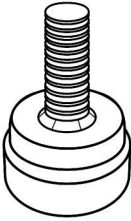
| PIÈCE / PART # | IMAGE | DESCRIPTION | QTY / QTÉ |
|----------------|---|--|-----------|
| A |  | ASSEMBLING BOLT - Ø1/4" X 1/2" BOULON D'ASSEMBLAGE - Ø1/4" X 1/2" | 8 |
| B |  | ASSEMBLING BOLT - Ø1/8" X 1/2" BOULON D'ASSEMBLAGE - Ø1/8" X 1/2" | 4 |
| C |  | ASSEMBLING SCREW - Ø1/8" X 1 3/8" VIS D'ASSEMBLAGE - Ø1/8" X 1 3/8" | 4 |
| D |  | CAP - 1/2" X 1" CAPUCHON - 1/2" X 1" | 4 |
| E |  | ADJUSTABLE LEG - Ø1/4" X 3/8" PATTE AJUSTABLE - Ø1/4" X 3/8" | 4 |

LISTE DES PIÈCES DE MONTAGE
HARDWARE LIST

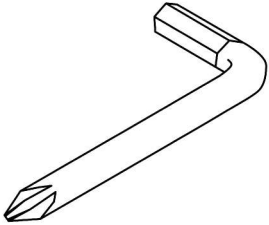
| PIÈCE / PART # | IMAGE | DESCRIPTION | QTY / QTÉ |
|----------------|---|---------------------------|-----------|
| F |  | HEX KEY CLÉ HEXAGONALE | 1 |

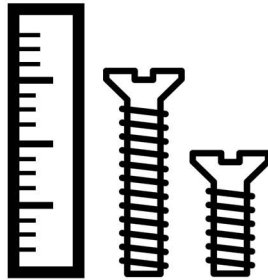

OUTIL DE VÉRIFICATION DE DIMENSIONS DES PIÈCES
HARDWARE DIMENSIONS VERIFICATION TOOL

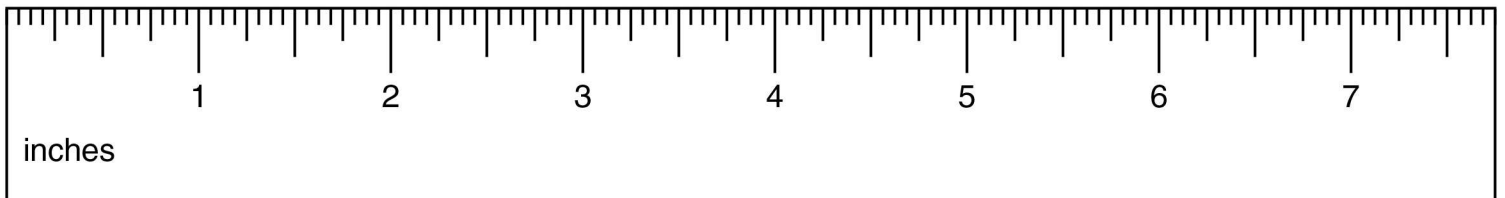

ÉTAPE / STEP 1

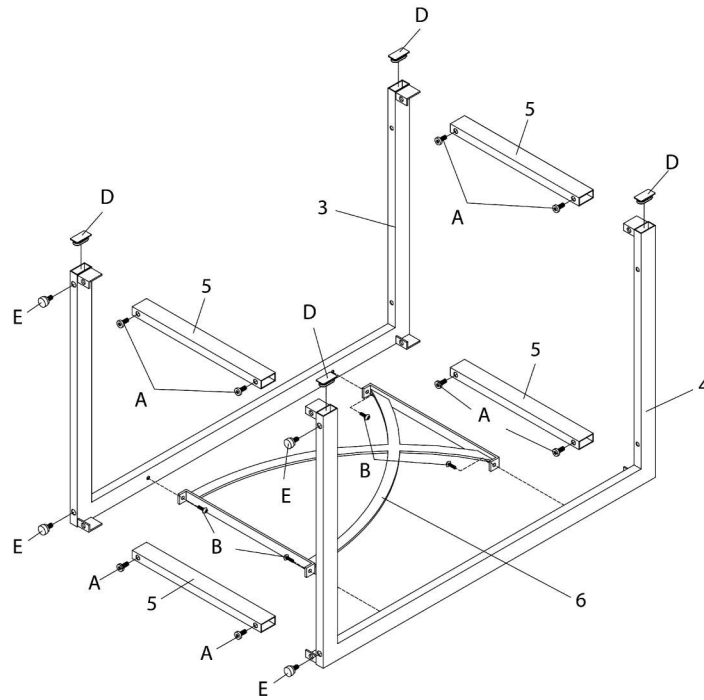

ÉTAPE / STEP 2

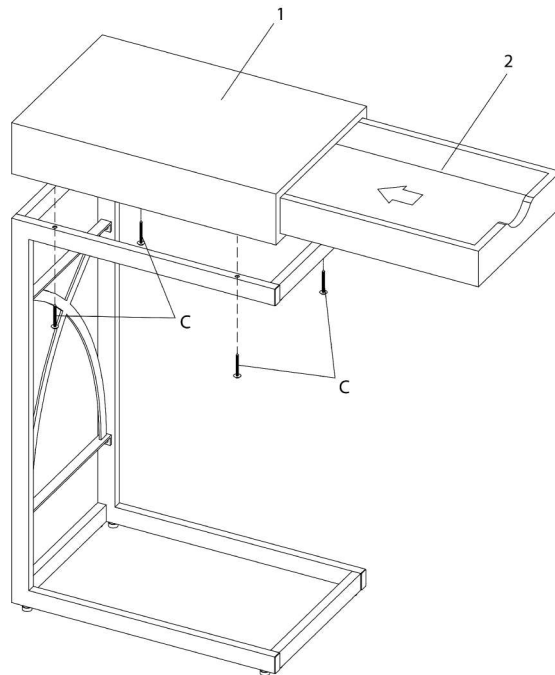

ÉTAPE / STEP 3

