

# ASSEMBLY INSTRUCTIONS

---

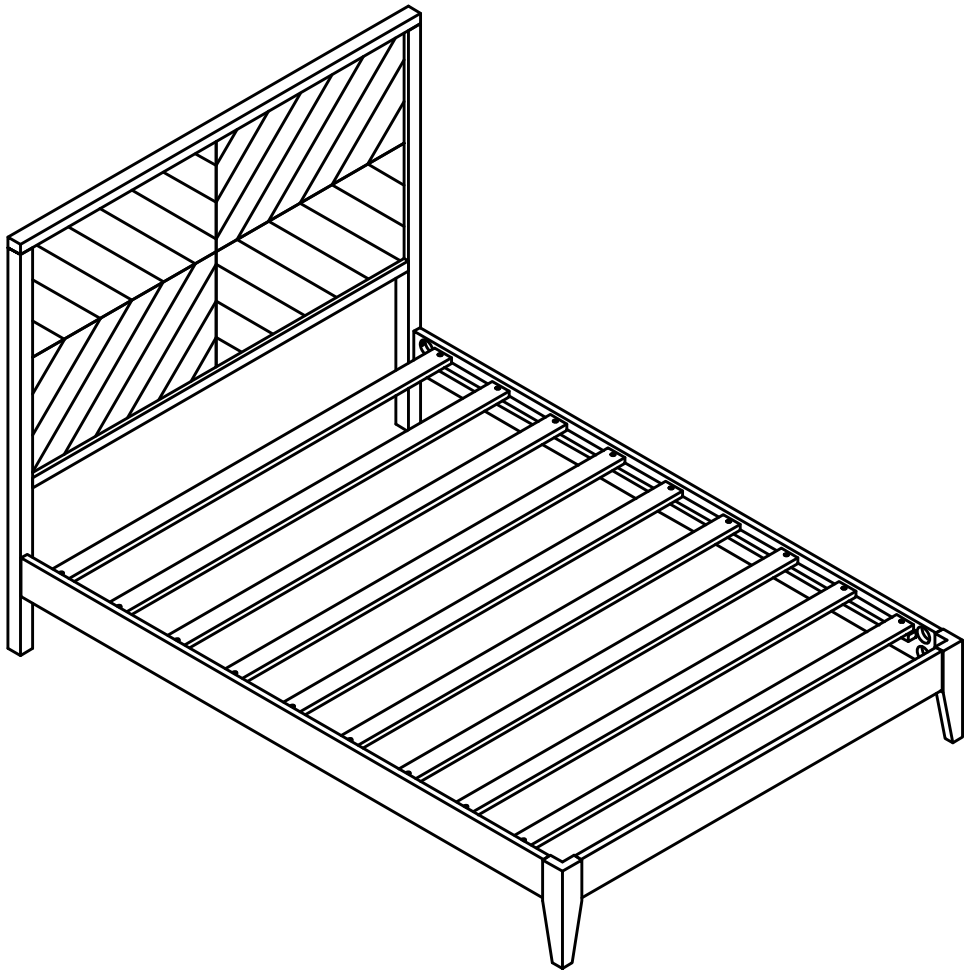

**WF531565AAA**

# PRE ASSEMBLY INTRODUCTION

We understand building ready-to-assemble furniture can be a challenging experience for some. To help avoid confusion, we have provided some helpful tips that may speed up the process.

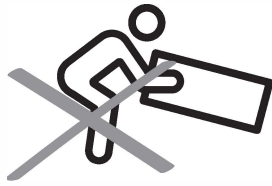

## Teamwork

ALWAYS have at least two people to help with transporting and assembling the product to avoid potential injury and/or damage.

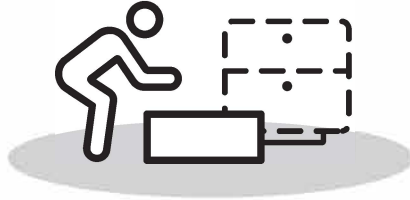
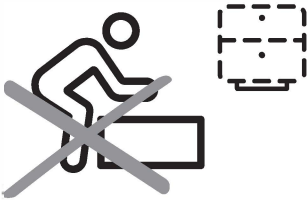

## Suitable Location

Assembling near the area of the intended location is highly recommended.



## Sufficient Space

Make sure you have enough space to move around during the assembly.



## Avoid Scratches

Use cardboard, blankets or a carpeted area while assembling furniture to prevent scratches.

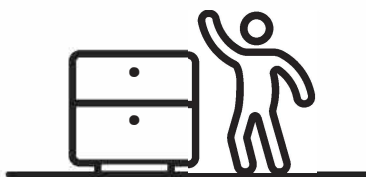
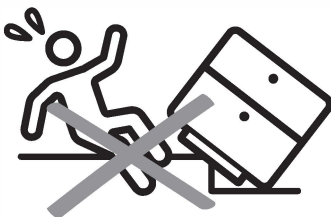

## Flat Surface

Make sure the furniture rests on a flat and level surface with each leg evenly touching the floor.

# PARTS

#A 1pc

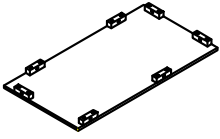

Panel Left HB  
(top)

#B 1pc

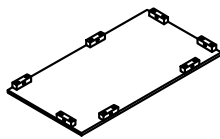

Panel Left HB  
(bottom)

#C 1pc

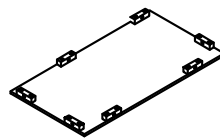

Panel Right HB  
(bottom)

#D 1pc

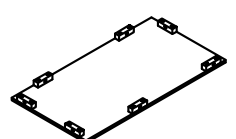

Panel Right HB  
(top)

#E 1pc

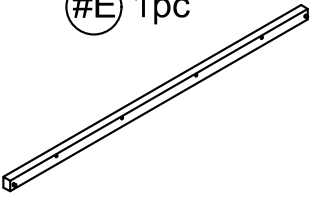

Top bar

#F 1pc

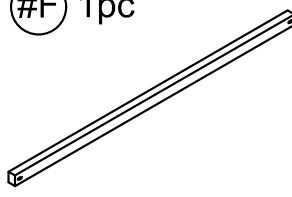

Bottom bar

#G 1pc

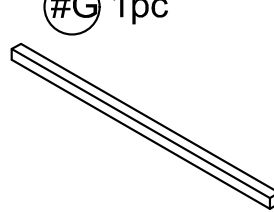

Leg HB right

#H 1pc

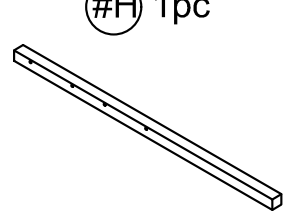

Leg HB left

#I 2pcs



Legs FB

#J 1pc

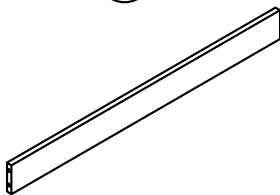

Panel FB

#K 1 set

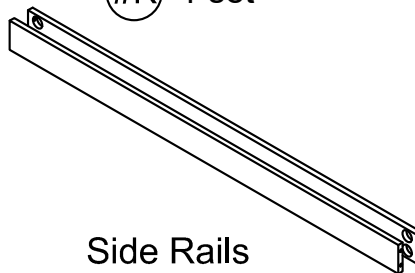

Side Rails

#L 9 pcs

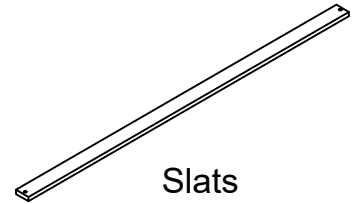

Slats

# HARDWARE

#1

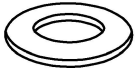

Flat Washer Ø1/4" x 22pcs

#2



Lock Washer Ø1/4" x 22pcs

#3



Bolt Ø1/4" x 35mm x 22pcs

#4

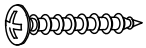

Screw Ø8 x 25mm x 18pcs

#5



Allen Key 4mm x 1pc

#6

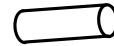

Wooden dowel Ø8 x 30mm x 2pcs

#7



Bolt Ø8 x 70mm x 8pcs

#8



Bolt Ø8 x 70mm x 8pcs

#9

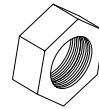

Bolt Ø8 x 70mm x 8pcs

#10

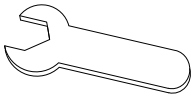

Allen Wrench 12mm

#11

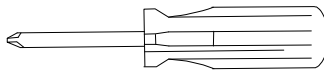

Screwdriver (Not Provided)

#12

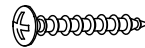

Screw Ø8 x 45mm x 2pcs

# ASSEMBLY INSTRUCTIONS

## Step 1

Attach Wooden dowel (#6) and Seat cushion (#B) on the Back chair (#A) by using Flat washer (#1), Lock washer (#2), Bolt (#3) with Allen key (#8).

- Part #A 1pc
- Part #B 1pc
- Hardware #1 2pcs
- Hardware #2 2pcs
- Hardware #3 2pcs
- Hardware #6 1pc

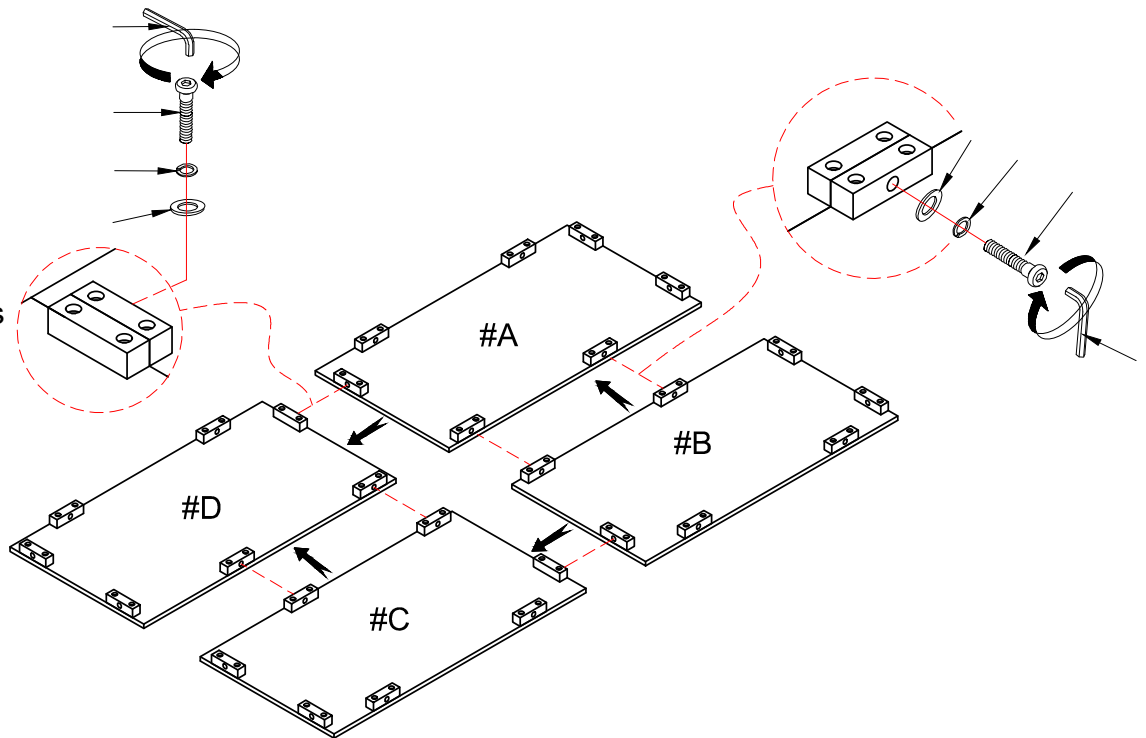

## Step 2

Then connect Seat cushion (#B) to the Back chair (#A) by using Flat washer (#1), Lock washer (#2), Bolt (#5) with Allen key (#8).

- Part #A 1pc
- Part #B 1pc
- Hardware #1 4pcs
- Hardware #2 4pcs
- Hardware #5 4pcs

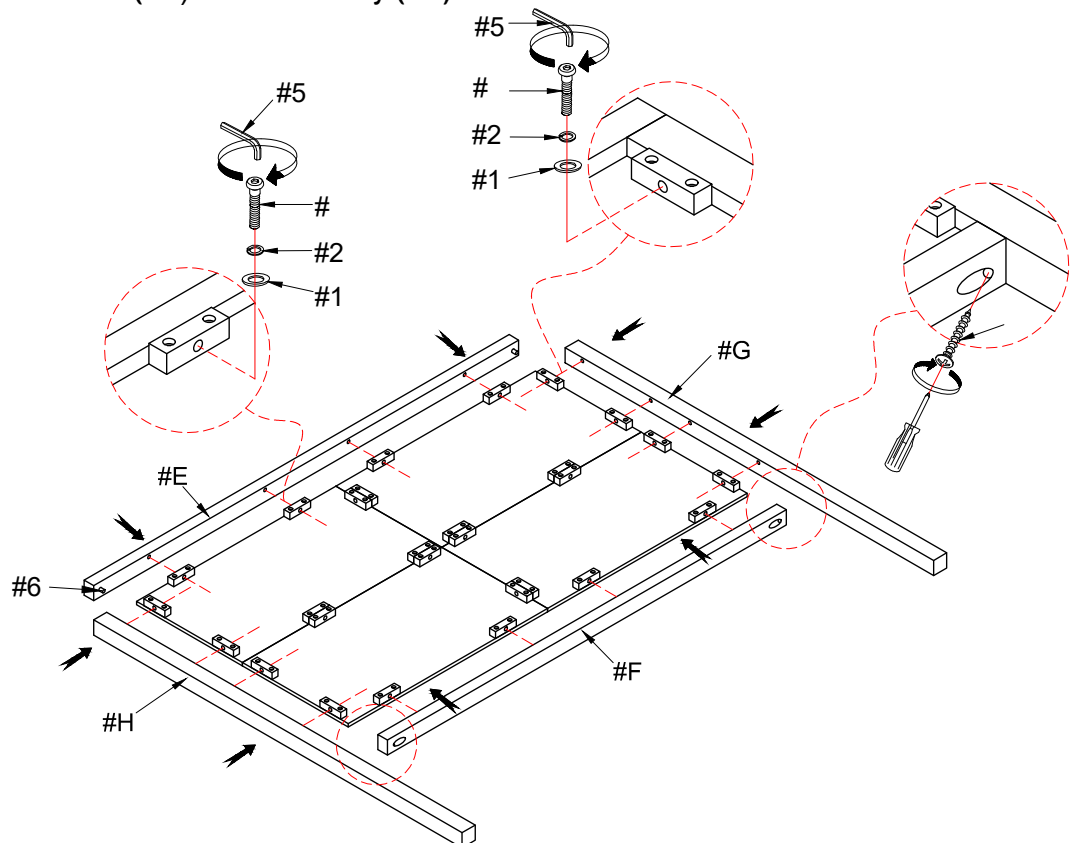

# ASSEMBLY INSTRUCTIONS

## Step 3

Attach Panel FB (#J), on the Legs FB (#I) by using Nut (#9), Flat washer (#1), Curved washer (#8), Bolt (#7) with Allen Wrench (#10).

- Part (#I) 2pcs
- Part (#J) 1pc
- Hardware (#7) 4pcs
- Hardware (#8) 4pcs
- Hardware (#2) 4pcs
- Hardware (#9) 4pcs
- Hardware (#10) 1pc

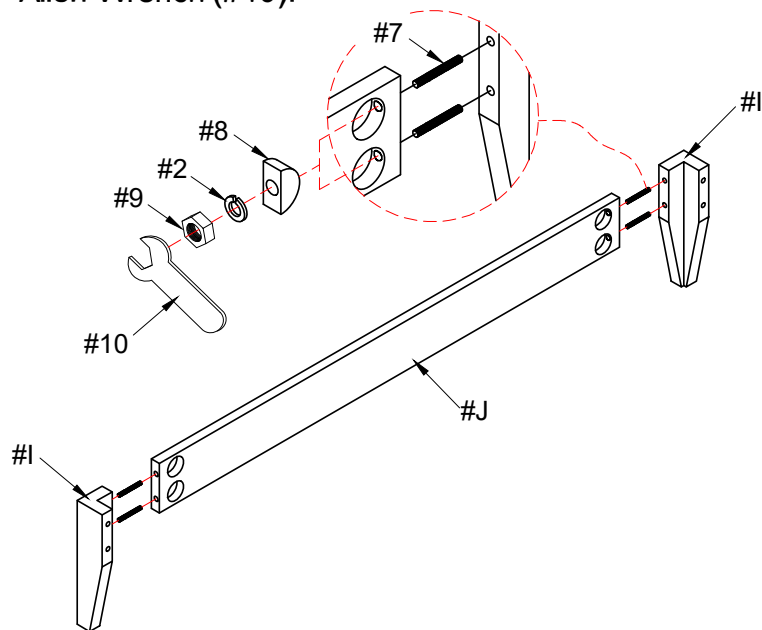

## Step 4

Attach Side rails (#K), on the Head board and Footboard by using Nut (#9), Flat washer (#1), Curved washer (#8), Bolt (#7) with Allen Wrench (#10).

- Part (#K) 1 set
- Hardware (#7) 8pcs
- Hardware (#8) 8pcs
- Hardware (#2) 8pcs
- Hardware (#9) 8pcs
- Hardware (#10) 1pc

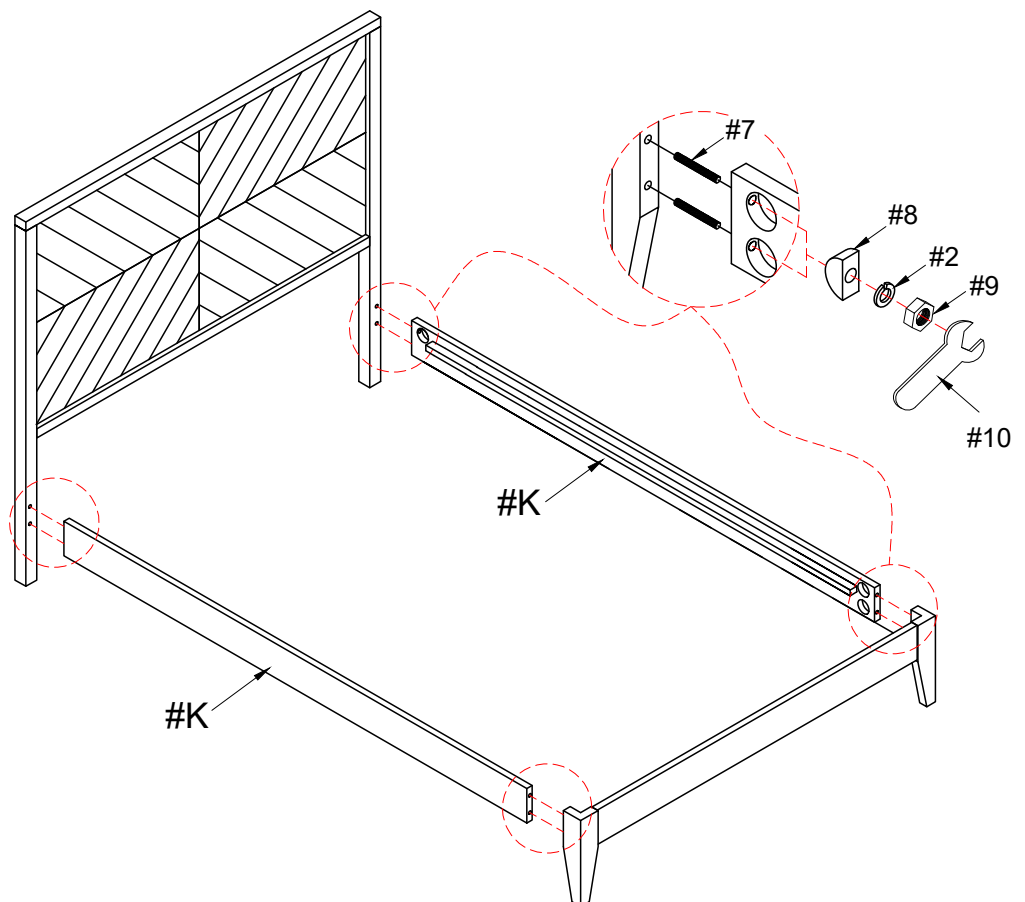

# ASSEMBLY INSTRUCTIONS

## Step 5

Then using Screw (#4) to connect Slats (#L) with Side rails (#K).

Hardware #4 18pcs

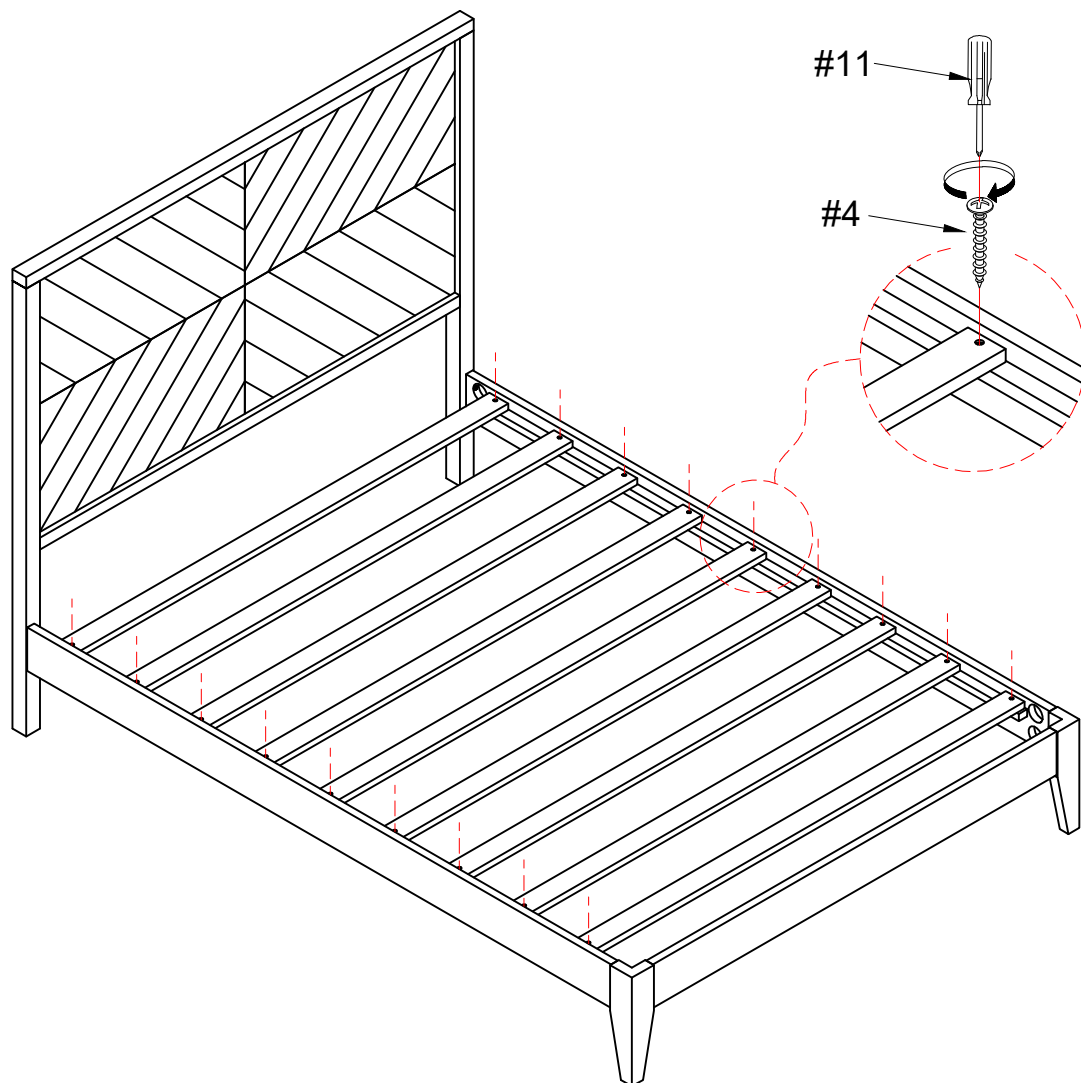

MADE IN VIETNAM